

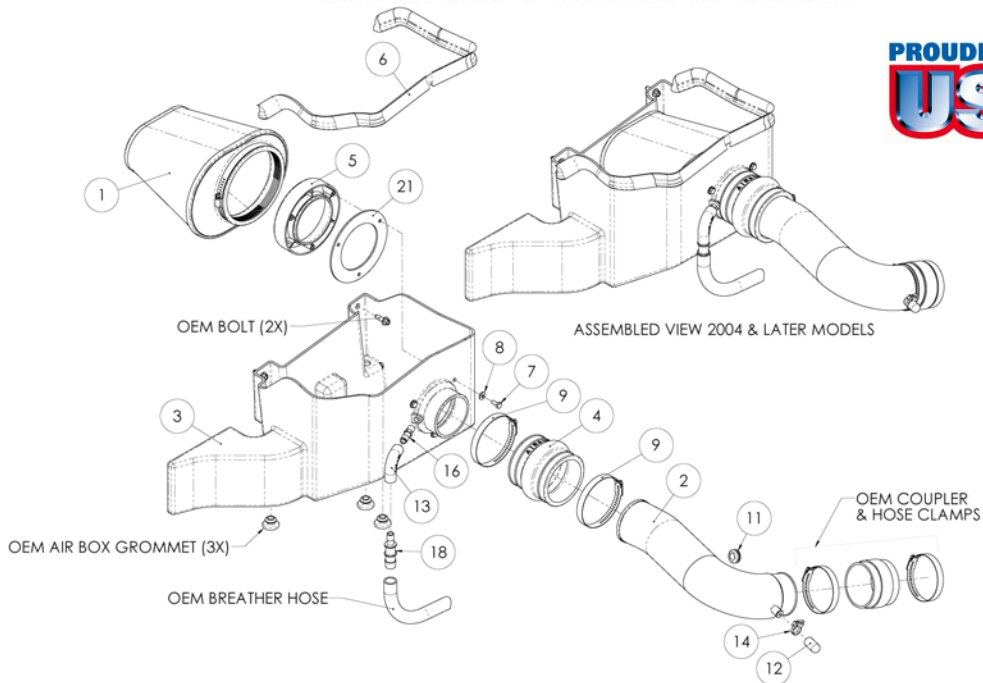

INTAKE SYSTEMS



Installation Instructions Part Number 300-224 2002-07 Dodge Ram 1500 4.7L V-8

Packing List:

#1	720-472	Airaid Premium Filter	1
#2	KIT925T	Airaid Intake Tube	1
#3	KIT220CAB	Cool Air Box	1
#4	KITHUMPHS02	Urethane Hump Hose	1
#5	KIT214FADA	Filter Adapter	1
#6	KITWSTRIP03	Weather Strip 33"	1
#6	KIT224HP	Hardware & Instructions	1
#7	KIT25C62HCSS	1/4-20 X 5/8" Hex Bolt	3
#8	KIT09FWZ019	1/4" Flat Washer	3
#9	KITHS60	#60 Hose Clamp	2
#10	KITGRMT01	Grommet Plug	1
#11	KITGRMT02	Grommet	1
#12	KIT106CAP	Rubber Cap	1
#13	KITELBOW04	1/2" x 90° Rubber Elbow	1
#14	KITSNPM4	#14 Speed Clamp	1
#15	KITSNP16M4	#16 Speed Clamp	3
#16	KITFITTING09	1/4"NPT x 1/2" Barbed Fitting	1
#17	KITFITTING04	1/4"NPT Hex Plug	1
#18	KITFITTING18	1/2" X 3/4" Barbed Connector	1
#19	KITHOSE01	1/2" x 4 1/2" Breather Hose	1
#20	KITELBOW01	1/2" x 1/2" Plastic Elbow	1
#21	KIT214G	Adapter Gasket	1

Tools Required For Installation:

5/16", 10mm, 13mm Sockets
7/16" Wrench
Ratchet & Extension

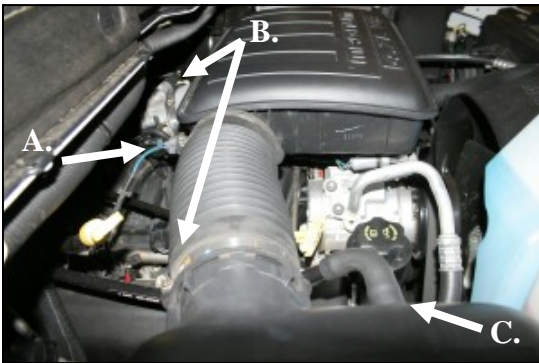

1. Disconnect the negative battery cable.
2003-07 Models A) Squeeze the tab on the intake air temperature sensor wiring connector on the back of the factory resonator, and disconnect it from the sensor. **All Models** B) Loosen two hose clamps. One on the back of the coupler on the throttle body, and one on the air filter lid side of the flexible intake tube. C) Disconnect the crankcase breather hose from the air filter lid.
2002 & 2003 Models; Disconnect the breather hose from the back of the resonator.



2. Slide the flexible intake tube off of the airbox lid and then lift the complete airbox straight up and out of the vehicle.



3. Turn the factory air box over and remove 3 of the 4 grommets. They will be reinstalled in the Airaid Cool Air Dam in step #8.



4. Using a 10mm socket, remove the two bolts that secure the intake resonator to the engine, one on the drivers side, and one on the passengers side of the resonator. Grab the resonator with both hands at the front and push back and up to release it from the locator grommet on the bottom. Remove the resonator from the vehicle.



5. Loosen the factory hose clamp on the coupler and remove the coupler assembly from the resonator. **2003-07 Models** Next gently push in on the temperature sensor and rotate it to the left and remove it from the resonator. These parts will be reinstalled on the Airaid intake tube in step #12.

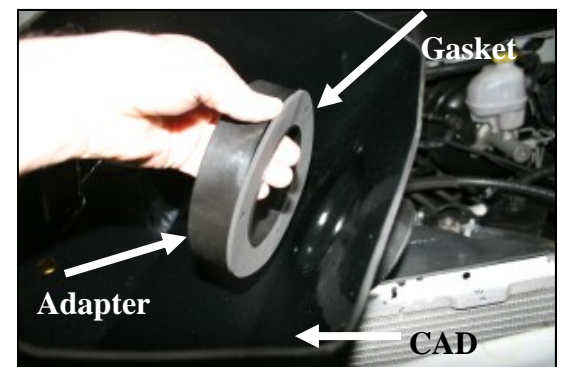

6. Install the filter gasket (#21) and filter adapter (#5) onto the Airaid Cool Air Dam (#3) as shown using three 1/4" x 5/8" bolts (#7), and 1/4" flat washers (#8). Refer to the line drawing above for reference.

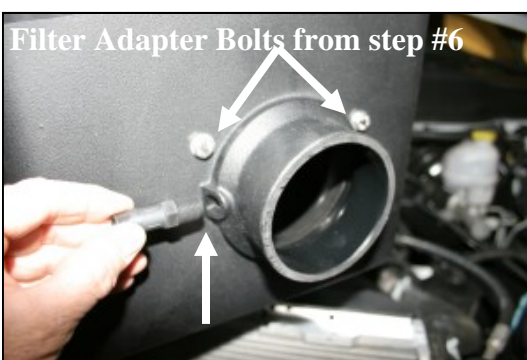

7. Install the 1/4" NPT x 1/2" Barbed fitting (#16) into the CAD as shown. **2002-03 Models** Install the 1/4" hex plug (#17) in place of the barbed fitting.

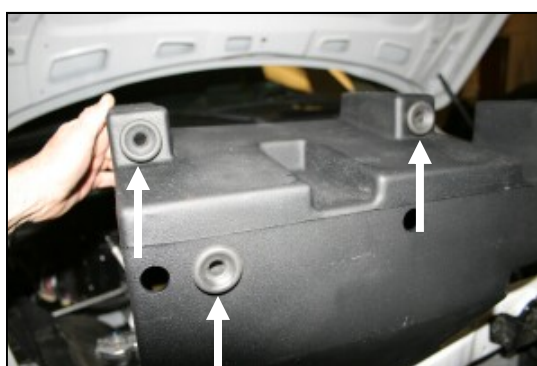

8. Install the factory grommets removed in step #3 into the bottom of the CAD at the locations shown here.



9. Remove the two bolts that secure the airbox mounting bracket to the inner fender. They will be reinstalled in step #10.

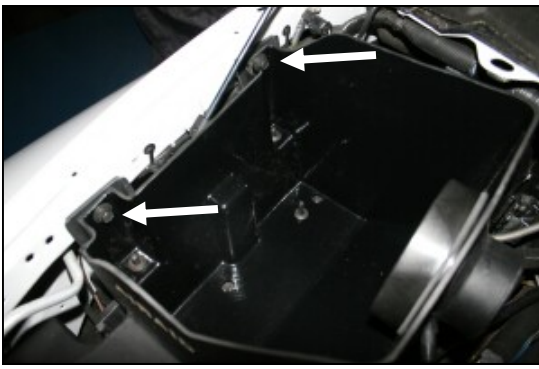

10. Install the CAD into the vehicle aligning the grommets over the locating pins. Reinstall the two factory bolts into the fender that were removed in step #9.

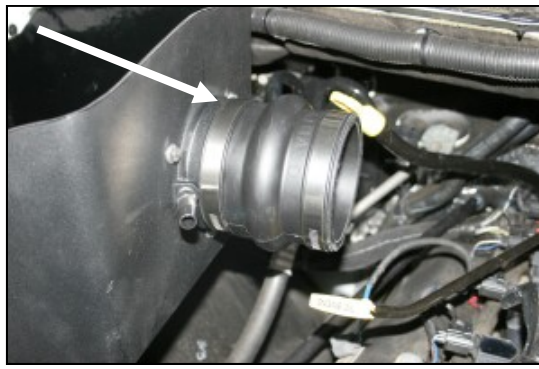

11. Install the hump hose onto the CAD using two #60 hose clamps (#9). Tighten the hose clamp on the CAD.

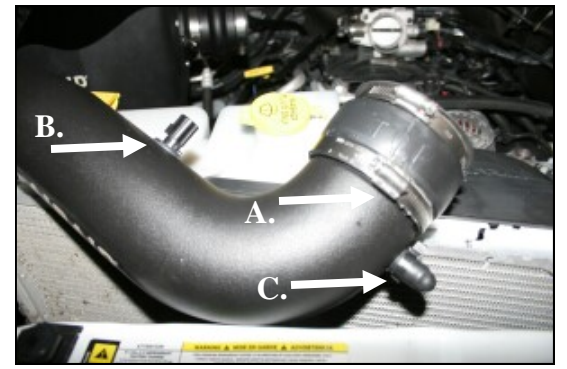

12. A.) Reinstall the factory coupler and hose clamps on to the Airaid intake tube (#2). Tighten the hose clamp on the tube. **2003-07 Models;** B.) Install the supplied grommet (#11) into the hole in the Airaid tube, and then carefully push the factory air temperature sensor into the grommet. **2002 Models;** Install the grommet plug (#10) in place of the grommet. **2004-07 Models;** C.) Slide the rubber cap (#12) over the nipple on the Airaid intake tube and secure it with the #14 speed clamp (#14).



13. Slide the Airaid intake tube into the hump hose first, and then onto the throttle body. Adjust for fit, and then tighten the two remaining hose clamps. **2003-07 Models;** Reconnect the temperature sensor wiring harness to the sensor in the tube.

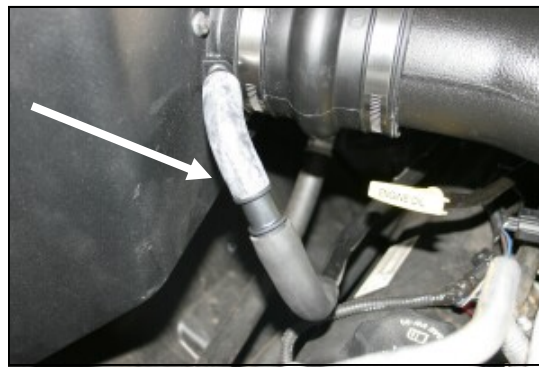

14. 2004-07 Models; Reconnect the factory breather hose to the 1/2" barbed fitting on the CAD using the 1/2" rubber elbow (#13), and 1/2"x 3/4" barbed fitting as shown.



15. 2002-03 Models; Install one end of the provided 90° barbed fitting (#20) into the factory breather hose and then connect the supplied 1/2" breather hose (#19) to the other end. Connect the hose to the nipple on the Airaid intake tube. Secure all three connections with the provided #16 Speed Clamps (#15).

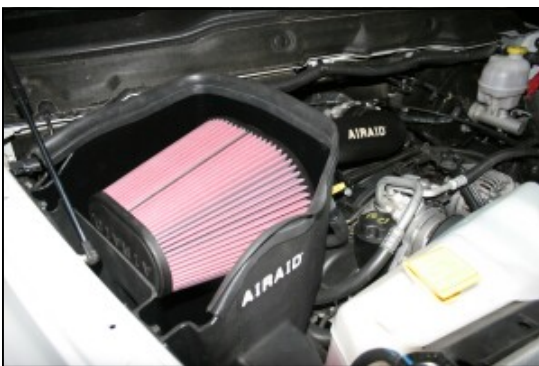

16. Install the Airaid Premium Filter (#1) onto the Airaid filter adapter, and tighten the hose clamp. Install the weather strip (#6) onto the top of the CAD, starting at the fender, and working your way towards the radiator.

17. Double check your work!

Make sure there is no foreign material in the intake path. Make sure all clamps, hoses, bolts, and screws are tight. Periodically check the tightness of all hose clamps.

18. Reconnect the negative battery cable!

Thank you for purchasing the Airaid Intake System. Contact Airaid @ (800) 498-6951 8:00 AM - 5:00 PM MST weekdays for questions regarding fit or instructions that are not clear to you. Your Airaid Intake System was carefully inspected and packaged. Check that no parts are missing, or were damaged during shipping. If any parts are missing, contact Airaid. The air filter element is protected from direct exposure to water and debris; care should be taken not to drive through deep water. WATER INGESTION IS THE DRIVERS RESPONSIBILITY! The air filter is reusable and should be cleaned using the Airaid Filter Tune-Up Kit periodically.

Before!



After!

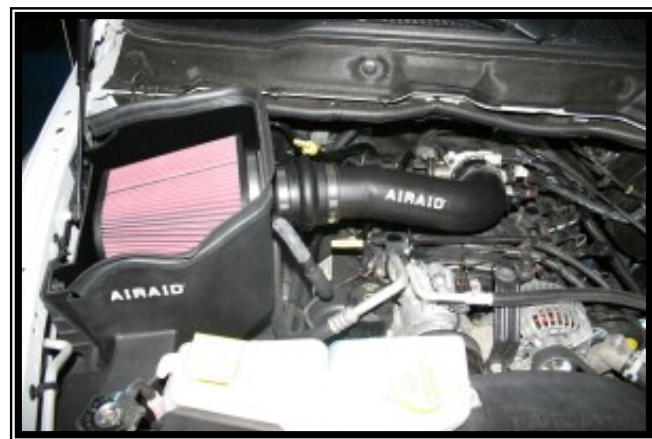

Don't Forget Your AIRAID Filter Tune-Up Kit!



P/N 790-551 Aerosol Spray
P/N 790-550 Squeeze Spray



Instructions Revision
Date: 02/14/08